

Maßzeichnung KEP(L) 1½, KEP(L) 2 und KEP(L) 2½

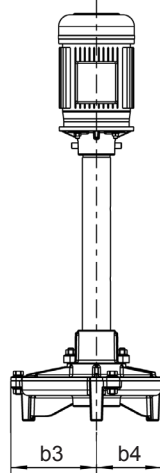

KEP

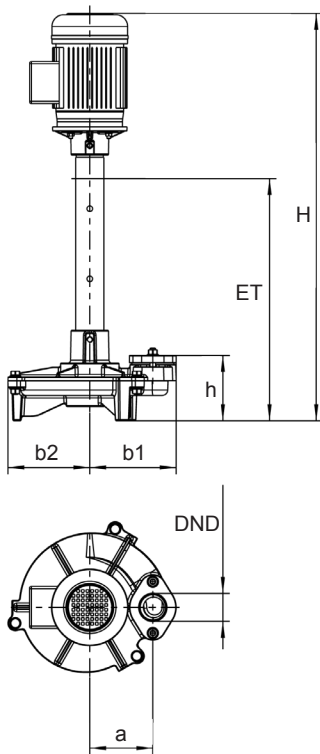
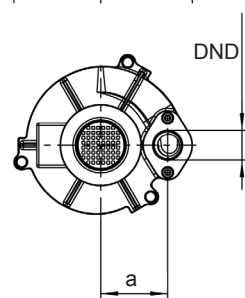
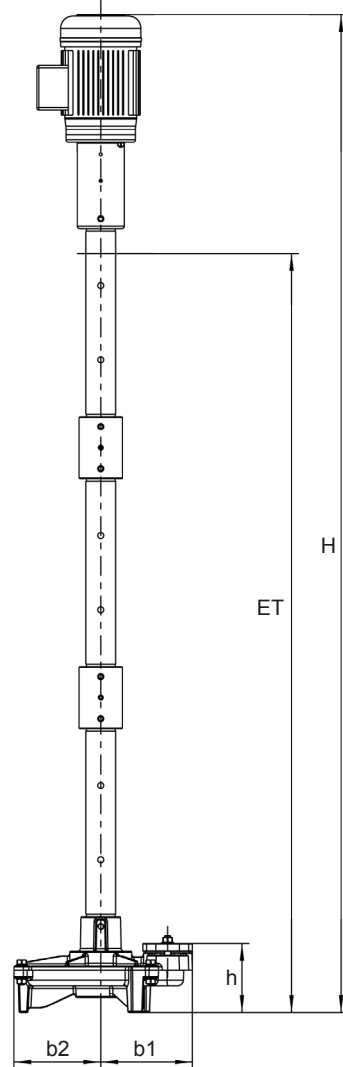

KEPL
mit Zwischenlager

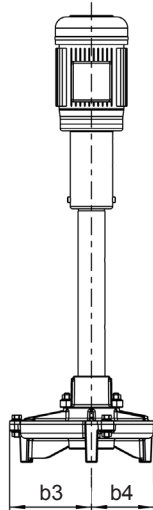
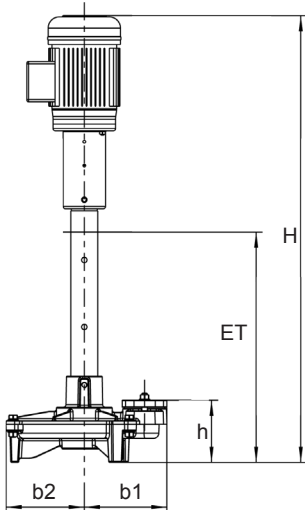

KEPL

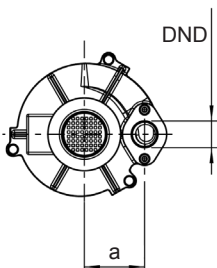

Maßzeichnung KEP(L) 1½, KEP(L) 2 und KEP(L) 2½

Typ	DN	a	b1	b2	b3	b4	h
KEP(L) 1½	G 1½	95	135	130	135	105	110
KEP(L) 2	G 2	135	185	178	183	140	139
KEP(L) 2½	G 2½	170	231	223	229	175	155

Typ	Motor		Einbautiefe (ET)																				
			0,65 m		1,0 m		1,25 m		1,65 m		2 m		2,3 m		2,65 m								
			H	kg	H	kg	H	kg	H	kg	H	kg	H	kg	H	kg							
KEP 1½ KEP-F 1½	0,55 - 1~	1450	1045	25,5	1395	28,5	1645	31															
	0,55/0,66	1450/1750							27	30	32,5												
	0,75 - 1~	1450		27		30		32,5															
	0,75/0,9	1450/1750																					
KEPL 1½ KEPL-F 1½	0,55 - 1~	1450	1165	27,5	1515	31	1765	33	2220	40	2570	43,5	2925	49,5	3275	52,5							
	0,55/0,66	1450/1750															29	32,5	34,5	41,5	45	51	54
	0,75 - 1~	1450		29		33,5		35,5		42,5		46		52		55							
	0,75/0,9	1450/1750																					
	1,1/1,3	2900/3500	1165	29	1515	39,5	1765	41,5	2220	48,5	2570	52	2925	58	3275	61							
	1,5/1,8	2900/3500															29	40,5	42,5	49,5	53	59	62
	2,2/2,6	2900/3500	1165	29	1515	51,5	1765	53,5	2220	60,5	2570	64	2925	70	3275	73							
	3,0/3,6	2900/3500															1165	29	1515	52,5	1765	54,5	2220
4,0/4,8	2900/3500																						
KEP 2 KEP-F 2	0,75 - 1~	1450	1145	40,5	1471	44	1695	46															
	0,75/0,9	1450/1750							40,5	44	46												
	1,1 - 1~	1450	1145	40,5		44		46															
	1,1/1,3	1450/1750							40,5	44	46												
	1,5 - 1~	1450			40,5		44					46											
	1,5/1,8	1450/1750	1145	40,5		1495		44	1745	46													
	2,2 - 1~	1450																					
2,2/2,6	1450/1750																						
KEPL 2 KEPL-F 2	0,75 - 1~	1450	1275	44	1555	39	1805	41,5	2210	48,5	2560	52	2965	58	3295	61							
	0,75/0,9	1450/1750															44	47	49,5	56,5	60	66	69
	1,1 - 1~	1450	1275	44		1599		1849		49,5		2254		56,5		2604							
	1,1/1,3	1450/1750															49	51,5	58,5	62	68	71	
	1,5 - 1~	1450			1275		53		1625		56		1875		58,5								2280
	1,5/1,8	1450/1750																					
	2,2 - 1~	1450																					
2,2/2,6	1450/1750																						
KEP 2½ KEP-B 2½ KEP-F 2½	2,2 - 1~	1450	1160	59,5	1510	63	1760	65															
	2,2/2,6	1450/1750							59,5	63	65												
	3,0/3,6	1450/1750		1160		68		1510				71,5	1760	73,5									
	4,0/4,8	1450/1750																					
KEPL 2½ KEPL-B 2½ KEPL-F 2½	2,2 - 1~	1450	1295	67	1645	70	1895	72,5	2350	79,5	2700	83	3055	89	3405	92							
	2,2/2,6	1450/1750															67	72	74,5	81,5	85	91	94
	3,0/3,6	1450/1750		1295		75,5		1667		78,5		1917		81		2372							
	4,0/4,8	1450/1750																					

Größere Einbautiefen auf Anfrage.